

DESCRIPTION OF RYLBRUN 32 ACCESSORIES

A) RYLBRUN 32 and 2" expansion terminals

1.- **Coupling** in AISI 316 Stainless steel with 1 1/4" GAS threaded end (32Grey, 32Black) and 2" GAS (2"Grey). (Fig.1)

2.- **Internal expansion ring** in stainless steel, thermally treated to make its subsequent mechanical expansion easy. (Fig.2)

3.- **Watertight gasket** manufactured in synthetic rubber. (Fig.3)

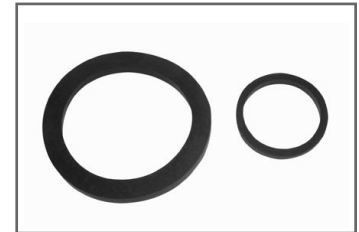
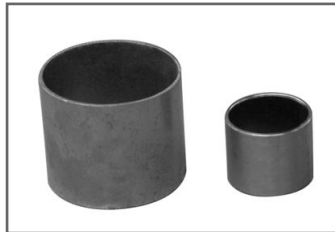

B) RYLBRUN 32 and 2" joint sleeves

Joint sleeve between Couplings, AISI 316 Stainless steel connection - 1 1/4" female to female gas thread.

Joint sleeve between Couplings, AISI 316 Stainless steel connection - 2" female to female gas thread.



C) Coupling machine

Easy to use tool allowing rapid and effective connection between piping and couplings by means of the expansion of the internal **expansion ring**

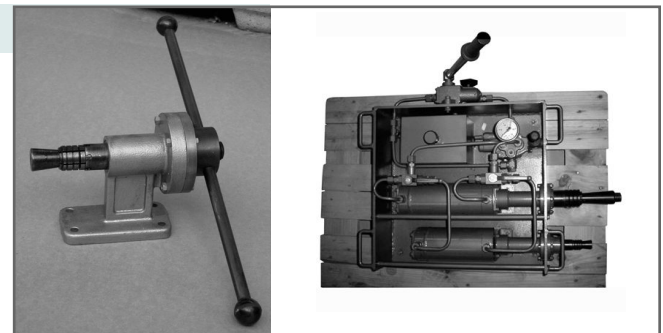

D) Well covers

For an external casing diameter of 210 mm.

For RYLBRUN 32 with 1 1/4" female thread on both sides (above and below).

For RYLBRUN 2" piping with 2" female thread on both sides (above and below).

DESCRIPTION OF RYLBRUN ACCESSORIES

E) Cable suspender

Open mesh of double loop and steel wire which allows the application of high traction forces to secure the suspension of the pump power supply cable at the well brink to avoid possible slipping. Its size will depend on the external diameter of the electrical cable.

Electrical cable external diameter		Sleeve length (mm)	Maximum Load (Kg)
Minimum (mm)	Maximum (mm)		
10	15	250	150
16	24	600	750
25	32	800	800
33	40	1200	1500
41	50	1500	2500
51	65	1500	2500
66	80	1900	2500
81	100	2000	3000



ESSENTIAL:

For installations of over 150 m of 32 mm diameter flexible piping.

F) Reducer - AISI 316 Stainless steel adaptor between the terminal and the pump (*).

* To order

G) Drainage system

This device was designed to empty the water column, whose high weight makes extraction difficult, from the piping.

This problem occurs in those installations where a check valve is used at the mouth of the pump.

This easy to install and use system allows us to completely empty the water column from the well mouth to the static level.

The system is made up of 3 parts: Plumb, fuse and drainage sleeve.



H) Removable mounting roller – For installation of piping of 32 mm to 6”.



DESCRIPTION OF RYLBRUN ACCESSORIES

RE-USABLE CONICAL COUPLINGS

Diámetros	2"	3"	4"	5"	6"
Material used	AISI 316 STAINLESS STEEL				
Male Thread Coupling	2" GAS	3" GAS	4" GAS	PN16 DIN FLANGE	
Female Threat Coupling	1"1/2 GAS	2"1/2 GAS	3" GAS		
Max. Diametre (mm)	100	130	160	205	248
Thread Length (mm)	234	291	352	-	-
Total Length (mm)	112	160	160	200	267
Weight (kg)	2,37	5,85	11,35	20,50	34,65
Key to be used	ALLEN8	ALLEN10	ALLEN14	ALLEN17	ALLEN17



RYLBRUN CONICAL HOSE – HOSE CONNECTORS

Diámetros	2"	3"	4"
Material used	AISI 316 STAINLESS STEEL		
Max. Diametre (mm)	100	130	166
Total Length (mm)	136	207	208
Key to be used	ALLEN8	ALLEN10	ALLEN14
Weight (kg)	3,64	9,20	14,16



RYLMATIC RE-USABLE COUPLINGS

Diámetros	2"	3"	4"
Material used	AISI 316 STAINLESS STEEL		
Male Thread Coupling	2"GAS	3"GAS	4"GAS
Max. Diametre (mm)	72,50	102,00	132
Thread Length (mm)	234	291	352
Total Length (mm)	218	263	296,5
Weight (kg)	2,67	6,05	-
Key to be used	Stillson Key		
	24"	48"	48"



DESCRIPTION OF RYLBRUN ACCESSORIES

GALVANISED IRON TERMINALS

fitted with threaded stainless steel couplings

ATTENTION: for installations of less than 50 m in depth

With welded flanges*	2"	3"	4"	5"	6"	
Connection	PN16 DIN FLANGE					
Max. diameter	139	183	219	252	285	
Total length (mm)	147	148	152	157	167	
Weight	2,33	4,27	6,42	8,90	11,28	
With thread *	2"	3"	4"	5"	6"	
Conexión	thread GAS 2"	thread GAS 3"	thread GAS 4"	thread GAS 5"	thread GAS 6"	
Max. diameter	60	88	113	138	164	
Thread length	234	291	352	-	-	
Total length (mm)	147	147	152	157	167	
Weight	0,99	1,60	2,50	3,59	5,07	* These terminals are coupled in our factory.

TOOLS FOR INSTALLING AND EXTRACTING PIPING

1.- Mounting roller.

	MEASUREMENTS
Large mounting roller	1500x840x800
Small mounting roller	750x420x400

2.- Clamps

There are two sizes.

Ensure the securing of the piping during installation.



3.- Eyebolts (only for 2", 3" and 4" conical, re-usable).

There are 3 sizes.

Thread connects directly to the female thread of the coupling and the ring is used as a traction hook.

